SAMPLE APPROVAL SHEET

DESCRIPTIONS:

- 5mm Rounded LED Lamps
- Emitting Color: RGB tri-color
- Lens Color: White Diffuse

CUSTOMER: _____

MASON P/N: **L5RGB-D2**

CUSTOMER P/N: _____

SMPLE DATE: **2014. 07. 08**

CUSTOMER APPROVED SIGNATURES

APPROVED BY	CHECKED BY



5mm Rounded full color LED



ATTENTION
OBSERVE PRECAUTIONS
FOR HANDLING
ELECTROSTATIC
DISCHARGE
SENSITIVE
DEVICES

Features

- z Low power consumption
- z Excellent product quality and reliability
- z I.c. compatible
- z Lead-free device.

Applications

- z Status indicators
- z Commercial use
- z Backlights
- z Advertising Signs

◆ Package Dimensions

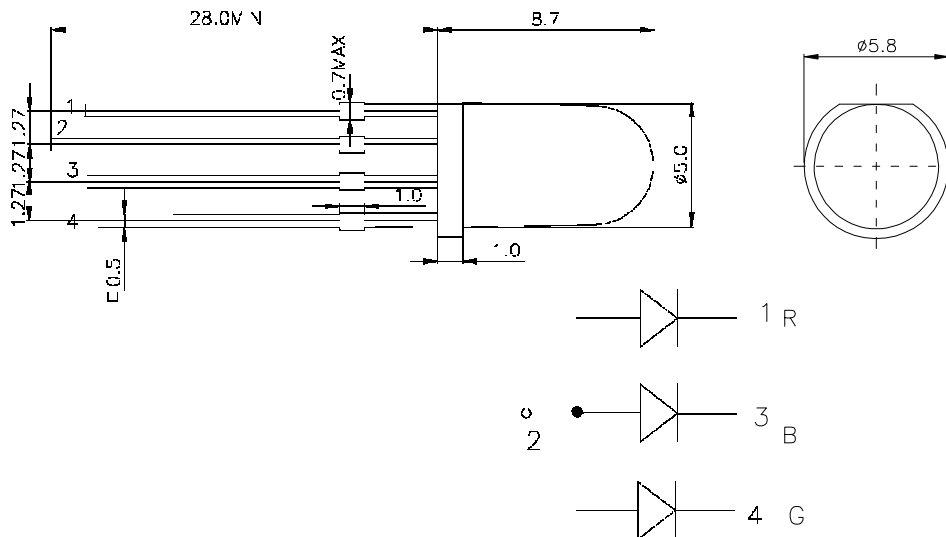

Notes:

1. All dimensions are in millimeters.
2. Tolerance is ± 0.25 unless otherwise noted.
3. Lead spacing is measured where the leads emerge from the package.
4. Specifications are subject to change without notice.

◆ Device Selection Guide

Part No.	Chip		Lens color
L5RGB-D2	Material	Emitted color	White Diffuse
	AlGaInP	Red	
	InGaN	Green	
	InGaN	Blue	

◆ Absolute Maximum Ratings at TA=25°C

Parameter	Symbol	Value			Unit
		Red	Green	Blue	
Power Dissipation	P _D	50	120	120	mW
Forward Current	I _F	30	30	30	mA
Peak Forward Current*1	I _{FP}	100	100	100	mA
Reverse Voltage	V _R	5	5	5	V
Operating Temperature	T _{opr}	-40°C To +85°C			
Storage Temperature	T _{stg}	-40°C To +85°C			
Soldering Temperature*2	T _{sol}	260°C For 5 Seconds			

Notes:

*1: Pulse width≤0.1ms, Duty cycles≤1/10

*2: 1.6mm below package base.

◆ Electrical / Optical Characteristics at TA=25°C

Parameter	Symbol	Min.	Typ.	Max	Unit	Test Conditions	
Forward Voltage	Red	V _F	1.8	2.00	—	V	IF=20mA
	Green	V _F	2.8	3.20	—	V	
	Blue	V _F	2.8	3.20	—	V	
Reverse Current	Red	I _R	—	—	10	μA	VR=5V
	Green	I _R	—	—	10	μA	
	Blue	I _R	—	—	10	μA	
Peak Wavelength	Red	λ _P	—	635	—		IF=20mA
	Green	λ _P	—	515	—		
	Blue	λ _P	—	465	—		
Luminous Intensity	Red	I _v	200	400	—	mcd	IF=20mA
	Green	I _v	300	600	—	mcd	
	Blue	I _v	100	200	—	mcd	
Power Angle	2θ1/2	—	80	—	Deg.	IF=20mA	

Remarks:

If special sorting is required (e.g. binning based on forward voltage, luminous intensity, or dominant wavelength), the typical accuracy of the sorting process is as follows:

1. Dominant Wavelength: +/-1nm
2. Chromatic Coordinates: +/-0.01
3. Luminous Intensity: +/-15%
4. Forward Voltage: +/-0.1V
5. The design and working Current for Led is not less than 2mA.

◆ **Typical Electrical/Optical Characteristics Curves**
(Ta=25°C Unless Otherwise Noted)

◆ **Red**

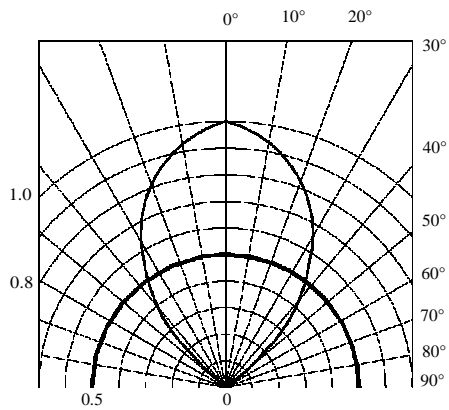
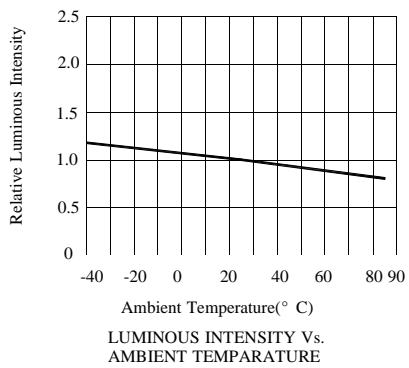
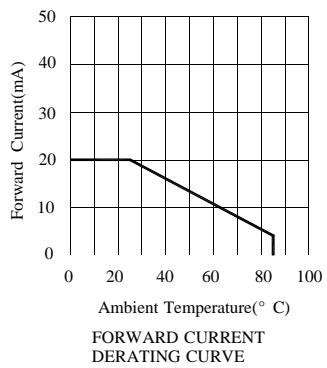
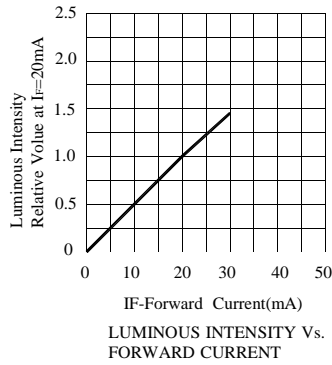
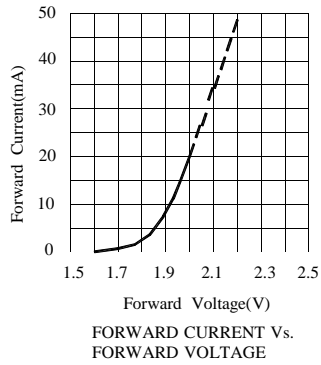
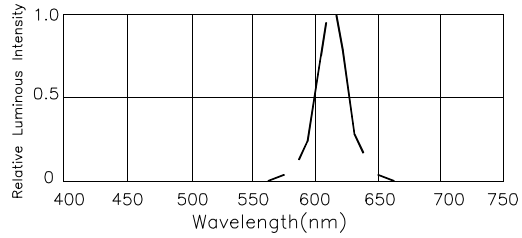

SPATIAL DISTRIBUTION

◆ Typical Electrical/Optical Characteristics Curves
 (Ta=25°C Unless Otherwise Noted)

◆ Green

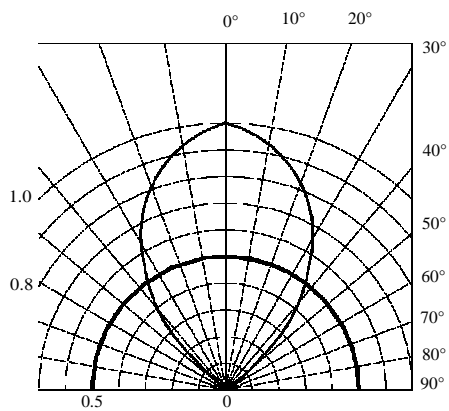
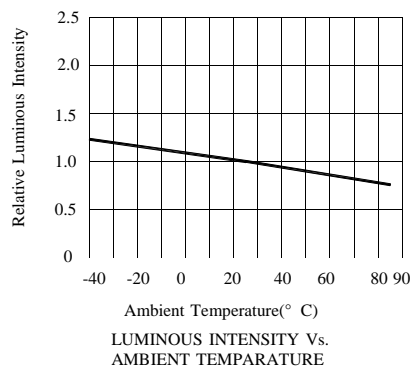
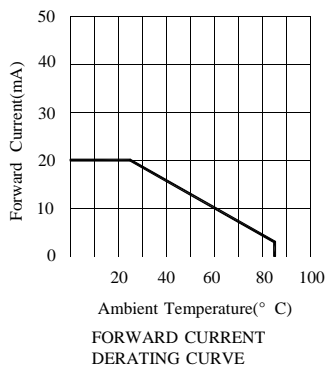
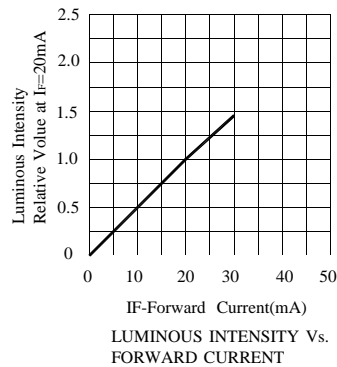
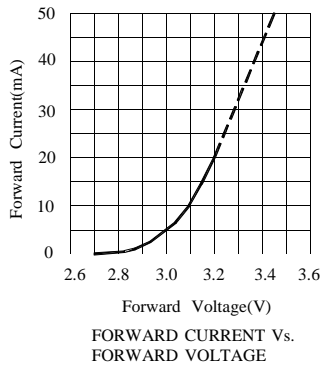
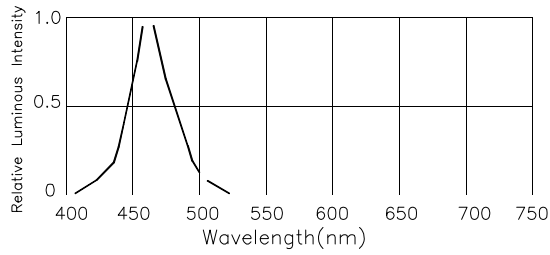

SPATIAL DISTRIBUTION

◆ Typical Electrical/Optical Characteristics Curves
 (Ta=25°C Unless Otherwise Noted)

◆ Blue

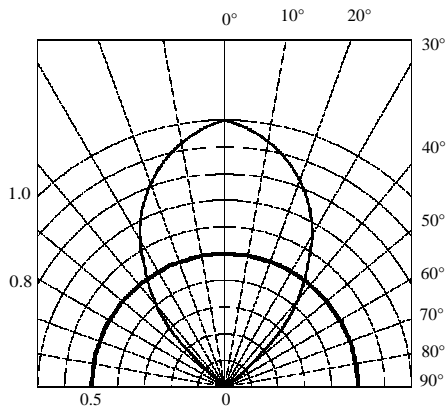
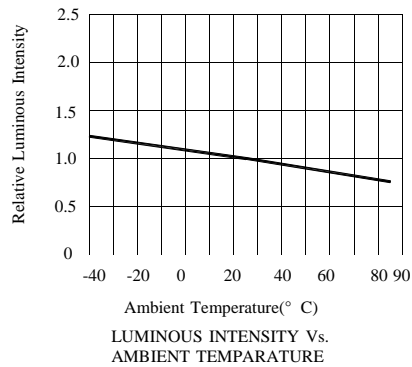
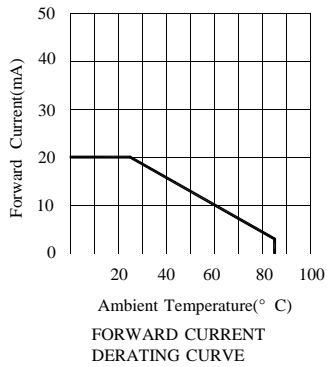
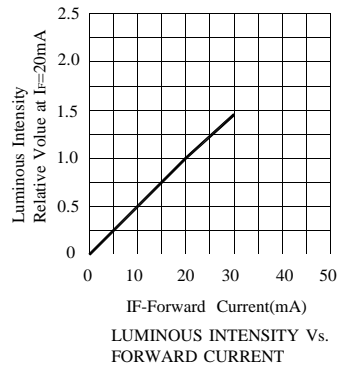
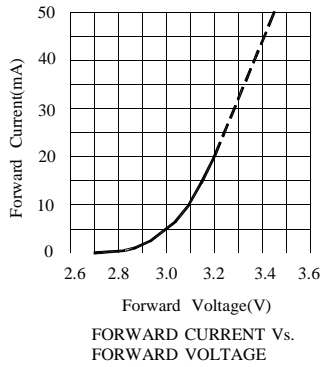
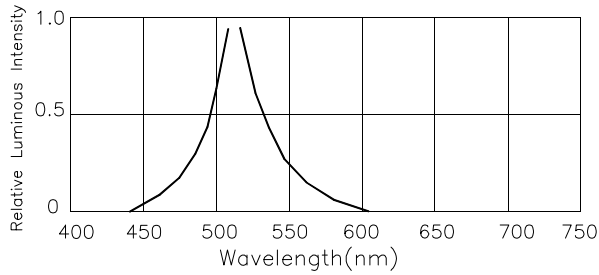

SPATIAL DISTRIBUTION

◆ CAUTIONS:

1. Lead Forming & Assembly

- Any lead forming or bending must be done before soldering, at normal temperature.
- When forming leads, there must be a minimum of 3mm clearance between the base of the LED lens and the lead bend.
- Do not use the base of the lead frame as a fulcrum during lead forming.
- Avoid bending the leads at the same point more than once.
- During assembly onto PCB, the lead pitch of the LED must match the pitch of the mounting holes on the PCB during component placement.

2. Cleaning:

- Isopropyl alcohol or deionized water are recommended solvents for cleaning. When using other solvents, it should be confirmed beforehand whether the solvents will dissolve the resin or not.

3. Storage

- The storage ambient for the LEDs should not exceed 30°C temperature or 70% relative humidity.
- It is recommended that LEDs out of their original packaging are used within three months. For extended storage out of their original packaging, it is recommended that the LEDs be stored in a sealed container with appropriate desiccant or in desiccators with nitrogen ambient.

4. ESD (Electrostatic Discharge)

Static Electricity or power surge will damage the LED.

The following procedures may decrease the possibility of ESD damage.

- All production machinery and test instruments must be electrically grounded.
- Use a conductive wrist band or anti-electrostatic glove when handling these LEDs.
- Maintain a humidity level of 50% or higher in production areas.
- Use anti-static packaging for transport and storage.

◆ Revision History:

Rev. No.	Change description	Date	Prepared by	Checked by	Approved by
A/0	New-made specification	2014/07/08	袁 苑		